

Barkbusters

www.barkbusters.net

FITTING INSTRUCTIONS for...

- TRIUMPH Tiger 800 (up to 2014)
- TRIUMPH Tiger 800XC (up to 2014)
- TRIUMPH Tiger 800XCX (2015 on)
- TRIUMPH Tiger 800XRX (2015 on)
- TRIUMPH Tiger 1200 Explorer

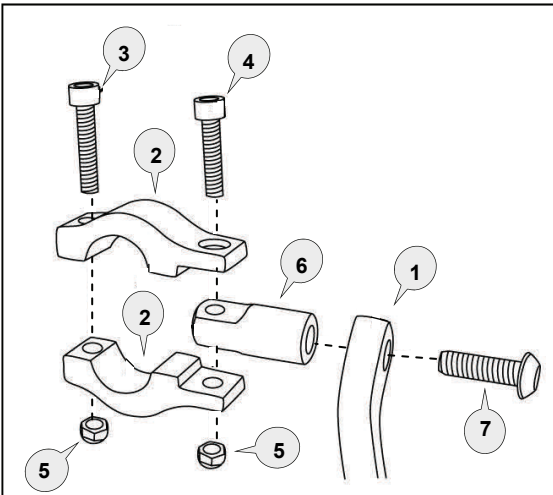

Important Fitting Procedure

There are rings machined into the inside of the tapered clamp surface to assist with a correct fit. The rings on both halves of the clamp should line up with each other and be positioned towards the centre of the motorcycle on the left and right side.

Loosely assemble clamp to handlebar as per diagram. Attach handguard with applicable parts to the handlebar and also to the clamp connector (6).

Note: Preferred backbone position is horizontal when viewed from side. **Tighten** (8 or 10)

Tighten Clamp bolts in the following order:

Tighten bolt (7) through the aluminium bar (1) to the clamp connector (6) of the clamp assembly.

Tighten bolt (4) to solidly lock the clamp connector (6) between the clamp saddles (2).

Tighten bolt (3) to secure the clamp assembly firmly to the handlebar.

Note: The clamp is designed to allow the nut on bolt (4) to pull into the recessed hole. This eliminates the need for a wrench after the bolt starts to tighten.

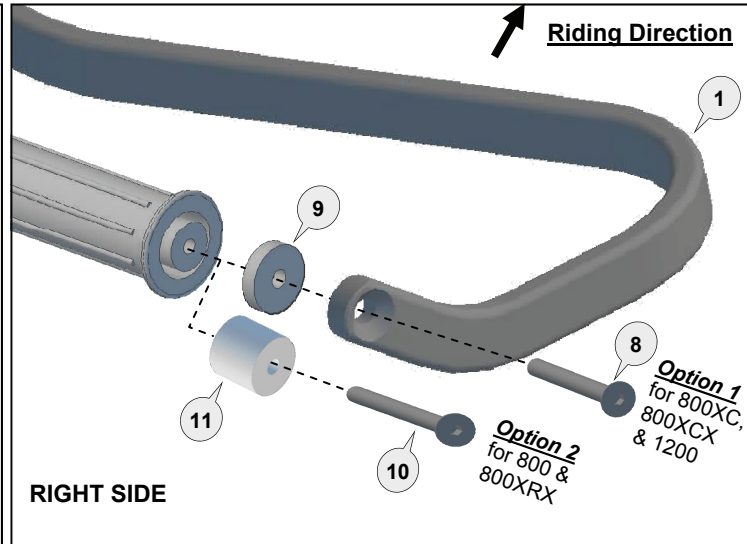

RIGHT SIDE

Fitting Tips for Tiger 800 & 800XC:

1. For best fit the handlebar should be positioned no lower than the centre mark but preferably at two marks above the centre mark. See Picture 1.
2. Position brake hose above the clamp and all cables below the clamp. See Picture 2.

Bar Side View

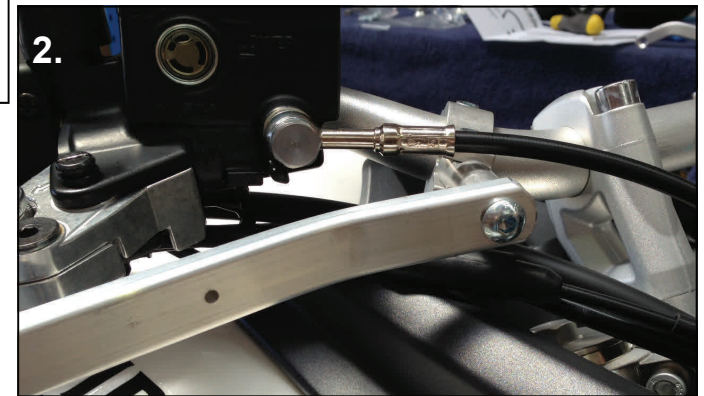
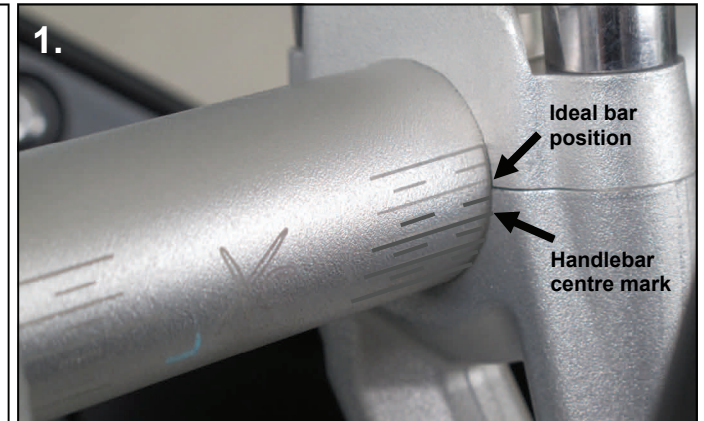
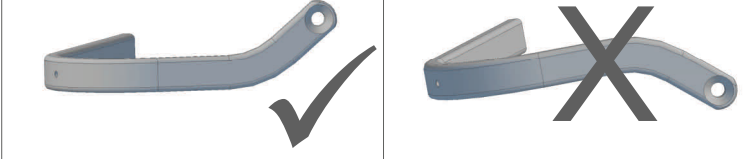





Personalise Your Protection

Guard options sold separately

JET	JET-003
VPS	VPS-003
Storm	STM-003
CARBON	BCF-003

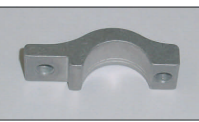
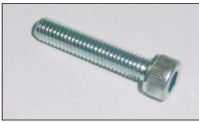

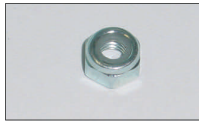
Phone: +61 (0)2 4271 8244
Email: info@barkbusters.net

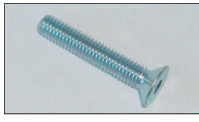
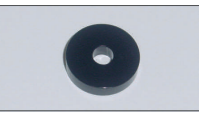
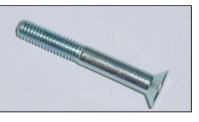
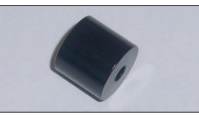
<p>1 Aluminium Bar</p>  <p>PN: BAR-V-053 Pcs. 1 Left & 1 Right</p>	<p>2 Clamp Saddle</p>  <p>PN: CS-02 Pcs. 2 Left & 2 Right</p>	<p>3 Socket Head Bolt 30mm</p>  <p>PN: M6x30SHCSZP Pcs. 2</p>	<p>4 Socket Head Bolt 25mm</p>  <p>PN: M6x25SHCSZP Pcs. 2</p>	<p>5 Nylock Nut 6mm</p>  <p>PN: M6LN Pcs. 4</p>	<p>6 Clamp Connector 60mm</p>  <p>PN: CP4 Pcs. 2</p>	<p>7 Button Head Bolt 25mm</p>  <p>PN: M8x25BHCSZP Pcs. 2</p>	<p>8 Flat Head Bolt 30mm</p>  <p>PN: M6x30FHCSZP Pcs. 2</p>
<p>9 Spacer</p>  <p>PN: SP-05 Pcs. 2</p>	<p>10 Flat Head Bolt 45mm</p>  <p>PN: M6x45FHCSZP Pcs. 2</p>	<p>11 Spacer</p>  <p>PN: SP20 Pcs. 2</p>					

Recommended Torque Settings	
M6	10 Nm (7.4 lbf ft)
M8	20 Nm (14.8 lbf ft)

CAUTION:

Installation of the handguard is safety-relevant work and can be complicated. We recommend the installation be performed by a motorcycle service technician. Rideworx accepts no liability for damages caused by improper mounting. All screws, bolts and nuts, including all replacement hardware provided by Rideworx, should be tightened to the torque specified in the below table. After the first 50km of riding check all screws, bolts and nuts are tightened to the correct torque. We recommend a medium strength liquid thread lock product on all fasteners.

WARNING:

It is important there is a working clearance (approx 3mm) between the throttle grip end and the handguard to ensure a free closing throttle. Check operation of all handlebar controls, specifically the throttle, front brake, kill switch and clutch to ensure they are operating correctly and are in accordance with the OEM specifications. Do not ride the motorcycle if any controls are not operating correctly. Check periodically that all bolts are tight.



Phone: +61 (0)2 4271 8244
Email: info@barkbusters.net
Web: www.barkbusters.net

Barkbusters

Disclaimer:

A failure to follow these fitting instructions could cause serious injury, death or property damage. These handguards are intended solely for use with motorcycles/ATV/snowmobiles/scooters that have not been modified. They are not designed to prevent injury or death while riding or in an accident or crash. The user must ensure that all controls are free of the handguards every time that they ride. By installing and/or using this product you acknowledge that you accept these terms and have followed the fitting instructions.