

# Barkbusters

www.barkbusters.net

## FITTING INSTRUCTIONS for...

- YAMAHA XTZ1200E Super Tenere ('14 on)

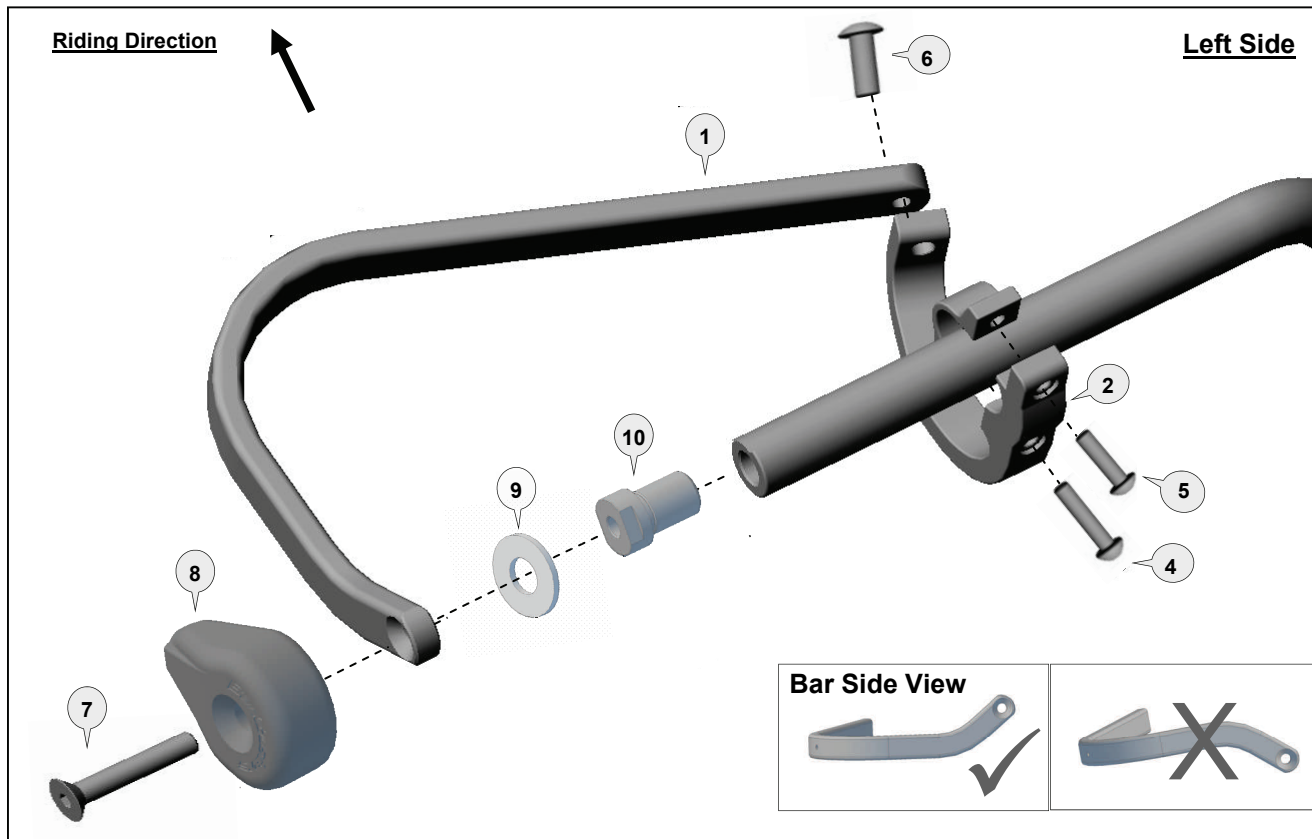

### Fitting Tips:

The pictures below show the correct position for the clamp relative to the handlebar controls.

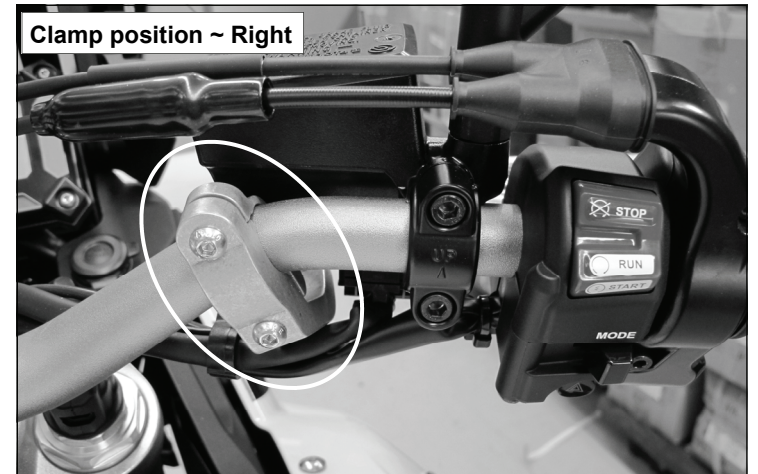
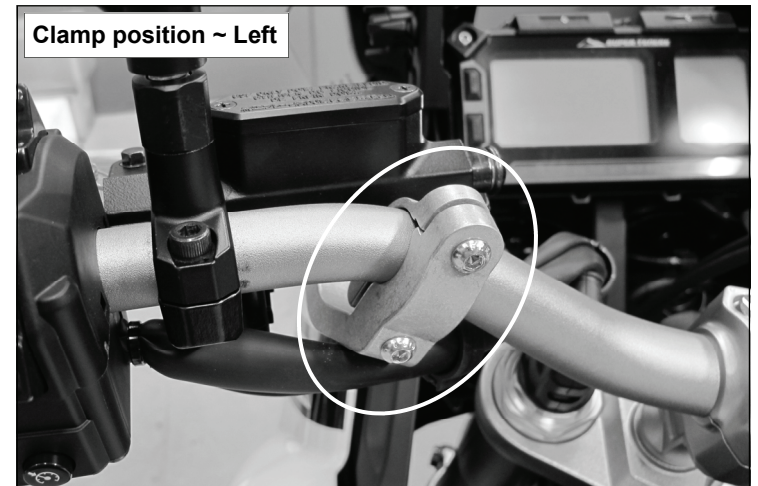

### Preparation

Remove original handguards and handlebar end weight.

### Fitting Procedure

Loosely assemble clamp to handlebar then attach aluminium backbone as per diagram.

**Note:** The preferred backbone position is horizontal when viewed from the side.

Tighten all bolts in the following order (7), (6), then (4 and 5).

Use recommended torque specifications over page.

### Personalise Your Protection

Guard options sold separately

<b>JET</b>	JET-003
<b>VPS</b>	VPS-003
<b>Storm</b>	STM-003
<b>CARBON</b>	BCF-003

**1** Aluminium Bar



PN: BAR-V-037  
Pcs. 2 (L & R)

**2** Clamp Frame & Saddle (left)



PN: CFS-ADV-L  
Pcs. 1

**3** Clamp Frame & Saddle (right)



PN: CFS-ADV-R  
Pcs. 1

**4** Button Head Bolt  
M6 x 30mm



PN: M6x30BHCSZP  
Pcs. 2

**5** Button Head Bolt  
M6 x 20mm



PN: M6x20BHCSZP  
Pcs. 2

**6** Button Head Bolt  
M8 x 20mm



PN: M8x20BHCSZP  
Pcs. 2

**7** Flat Head Bolt  
M8 x 45mm



PN: M8x45FHCSZP  
Pcs. 2

**8** Bar End Weight



PN: BEW2  
Pcs. 2

**9** Washer  
8mm

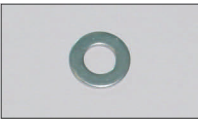

PN: M8FW  
Pcs. 2

**10** Bar End Steel Fitting



PN: BESF2  
Pcs. 2

Recommended Torque Settings	
M6	10 Nm (7.4 lbf ft)
M8	20 Nm (14.8 lbf ft)

**CAUTION:**

Installation of the handguard is safety-relevant work and can be complicated. We recommend the installation be performed by a motorcycle service technician. Rideworx accepts no liability for damages caused by improper mounting. All screws, bolts and nuts, including all replacement hardware provided by Rideworx, should be tightened to the torque specified in the table. After the first 50km of riding check all screws, bolts and nuts are tightened to the correct torque. We recommend a medium strength liquid thread lock product on all fasteners.

**WARNING:**

Check operation of all handlebar controls, specifically the throttle, front brake, kill switch and clutch to ensure they are operating correctly and are in accordance with the OEM specifications. Do not ride the motorcycle if any controls are not operating correctly or if rear view mirror vision is obscured. Check periodically that all bolts are tight.



Phone: +61 (0)2 4271 8244  
Email: [info@barkbusters.net](mailto:info@barkbusters.net)  
Web: [www.barkbusters.net](http://www.barkbusters.net)



**Disclaimer:**

A failure to follow these fitting instructions could cause serious injury, death or property damage. These handguards are intended solely for use with motorcycles/ATV/snowmobiles/scooters that have not been modified. They are not designed to prevent injury or death while riding or in an accident or crash. The user must ensure that all controls are free of the handguards every time that they ride. By installing and/or using this product you acknowledge that you accept these terms and have followed the fitting instructions.