

TN6415 - KN6415

PARAMOTORE SPECIFICO - SPECIFIC ENGINE GUARD - PARE-CARTER SPECIFIQUE - SPEZIFISCHER STURZBÜGEL - DEFENSA DE MOTOR ESPECÍFICA - PARAMOTOR ESPECÍFICO

TRIUMPH TIGER 900 (2020)

N°	Descrizione/Description	Caratteristiche/Features	Codice/Code	Quantità/Quantity
1	Paramotore - Engine Guard Pare-carter - Sturzbuegel Defensa De Moto - Paramotor	-	TN6415DXV TN6415SXV	2 (Right:Left)
2	Piastrina di supporto - Support plate Plaque de support - Trägerplatte Pletina de soporte - Placa de apoio	LEFT SIDE	GL4448V	1 (Left)
3	Piastrina di supporto - Support plate Plaque de support - Trägerplatte Pletina de soporte - Placa de apoio	RIGHT SIDE	GL4447V	1 (Right)
4	Vite - Screw Vis - Schraube Tornillo - Parafuso	TE M10x60	1060TENS	4
5	Vite - Screw Vis - Schraube Tornillo - Parafuso	TE M10x90 passo 1,25	1090TES	1
6	Vite - Screw Vis - Schraube Tornillo - Parafuso	TE M10x120 passo 1,25	10120TES	1
7	Vite - Screw Vis - Schraube Tornillo - Parafuso	TCE M8x20	820TCE	2
8	Rondella Spaccata Inox - Stainless Steel Washer Rondelle Inox -Rostfreie Unterlegscheibe Aus Stahl Arandela Inox - Arruela De Aço Inox	Foro Ø10mm	10RONSX	6
9	Rondella Inox - Stainless Steel Washer Rondelle Inox -Rostfreie Unterlegscheibe Aus Stahl Arandela Inox - Arruela Lisa De Aço Inox	Foro Ø10mm Sp. 1mm	101RON	6
10	Rondella spaccata - Split washer Scheibe - Rondelle fendue Arandela seccionada - Arruela Dentada	Ø8mm	Z1060	2
11	Rondella Inox - Stainless Steel Washer Rondelle Inox -Rostfreie Unterlegscheibe Aus Stahl Arandela Inox - Arruela Lisa De Aço Inox	Foro Ø8mm Esterno Ø20mm Sp.2mm	820RON	2
12	Rondella Inox - Stainless Steel Washer Rondelle Inox -Rostfreie Unterlegscheibe Aus Stahl Arandela Inox - Arruela Lisa De Aço Inox	Foro Ø10,5mm Esterno Ø25mm Sp.2,5mm	GL4449	1
13	Distanziale - Spacer Entretoise - Distanzstueck Distanciador - Espaçador	Ø24x26 Foro 10,5mm	C24L26F10,5T	3
14	Distanziale - Spacer Entretoise - Distanzstueck Distanciador - Espaçador	Ø18x20 Foro 14mm	C18L20F14FET	2
15	Distanziale - Spacer Entretoise - Distanzstueck Distanciador - Espaçador	Ø16x15,5 Foro 12mm	C16L15,5F12FET	2
16	Coprivite - Screw Cap Cache Vis - Stoppschraube Tapa Tornillo - Capa do Parafuso	-	17COP	4
17	Componenti Originali - Original Parts Parties Originales - Original Bauteile Componentes Originales - Componentes Originais	-	-	-

TN6415 - KN6415

TRIUMPH TIGER 900 (2020)

PARAMOTORE SPECIFICO - SPECIFIC ENGINE GUARD - PARE-CARTER SPECIFIQUE - SPEZIFISCHER STURZBÜGEL - DEFENSA DE MOTOR ESPECÍFICA - PARAMOTOR ESPECÍFICO

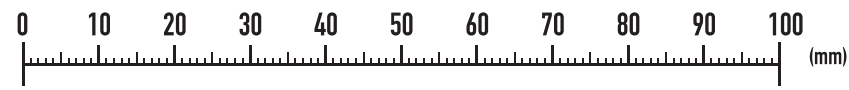
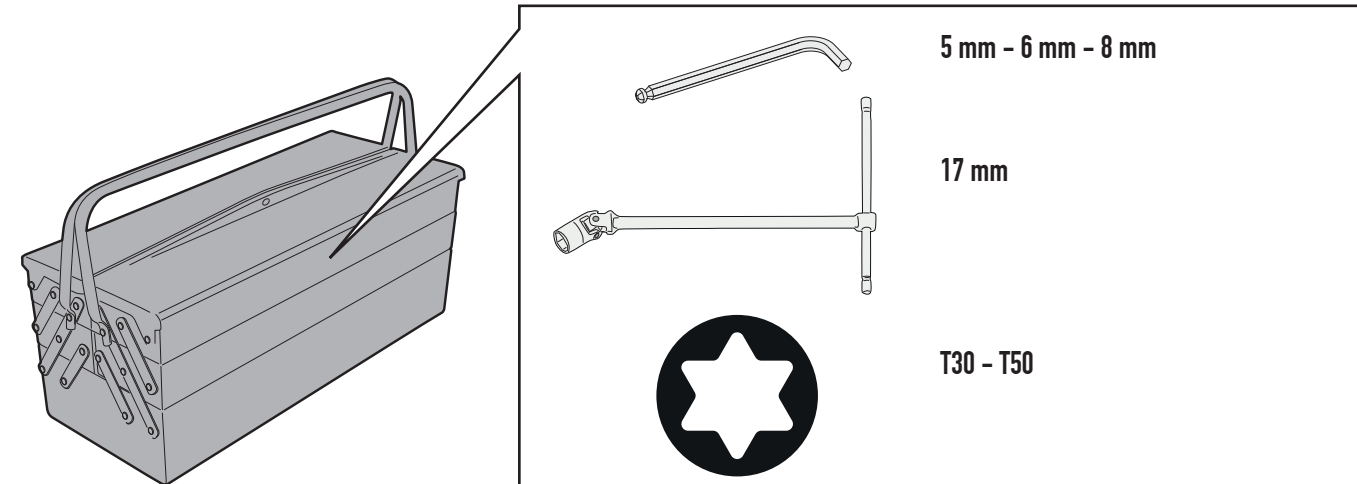
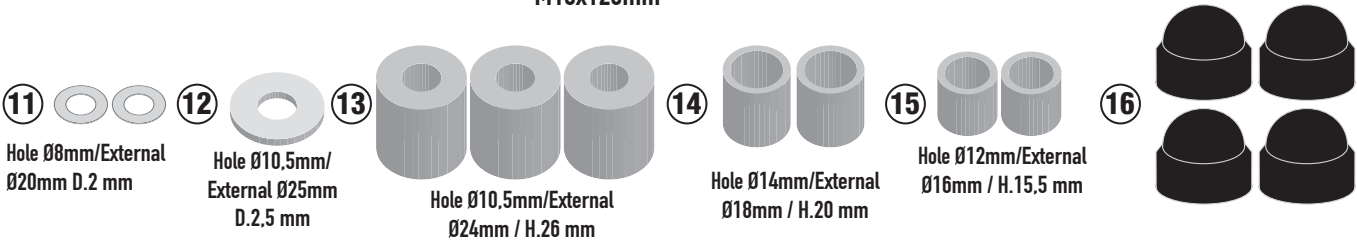
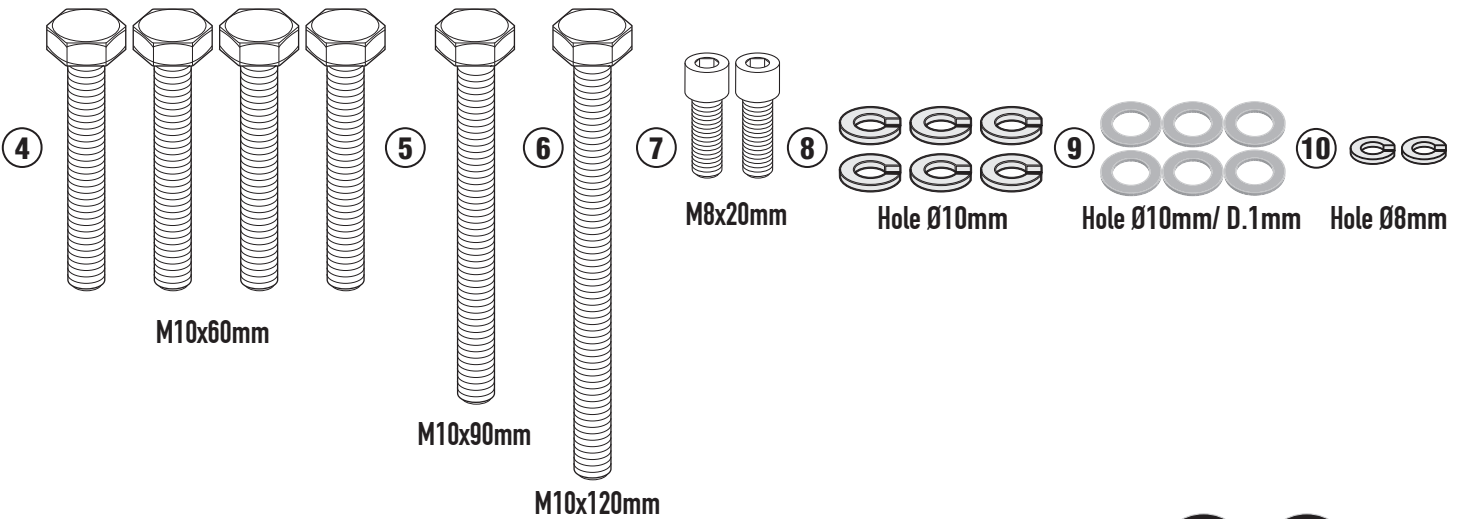
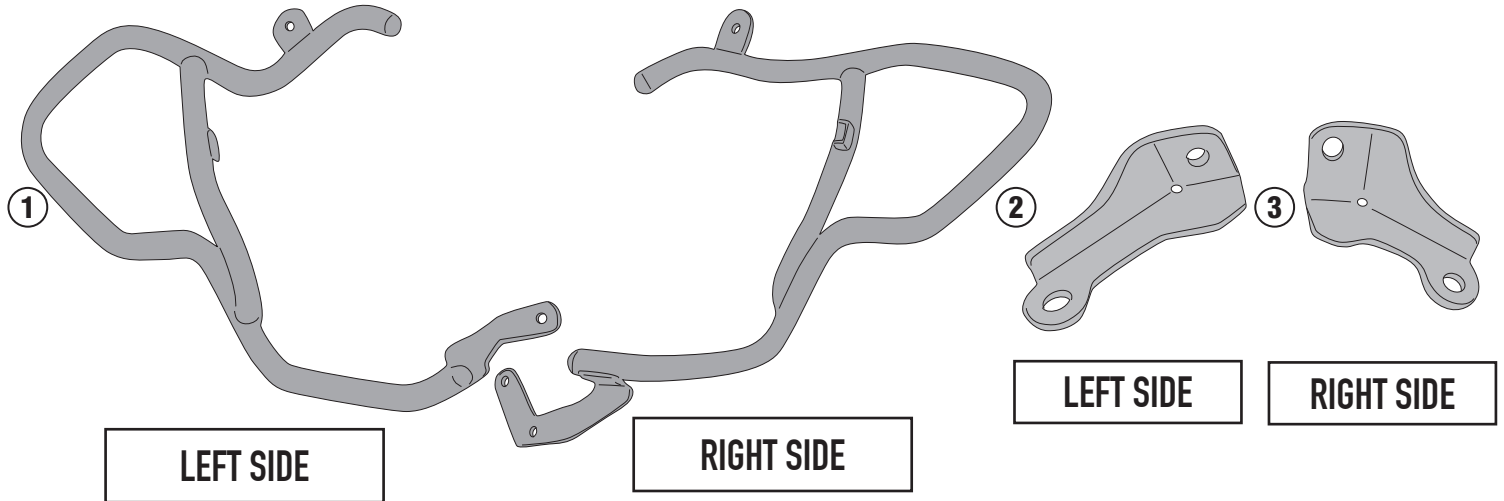

TN6415 - KN6415

TRIUMPH TIGER 900 (2020)

PARAMOTORE SPECIFICO - SPECIFIC ENGINE GUARD - PARE-CARTER SPECIFIQUE - SPEZIFISCHER STURZBÜGEL - DEFENSA DE MOTOR ESPECÍFICA - PARAMOTOR ESPECÍFICO

RIGHT SIDE / LEFT SIDE

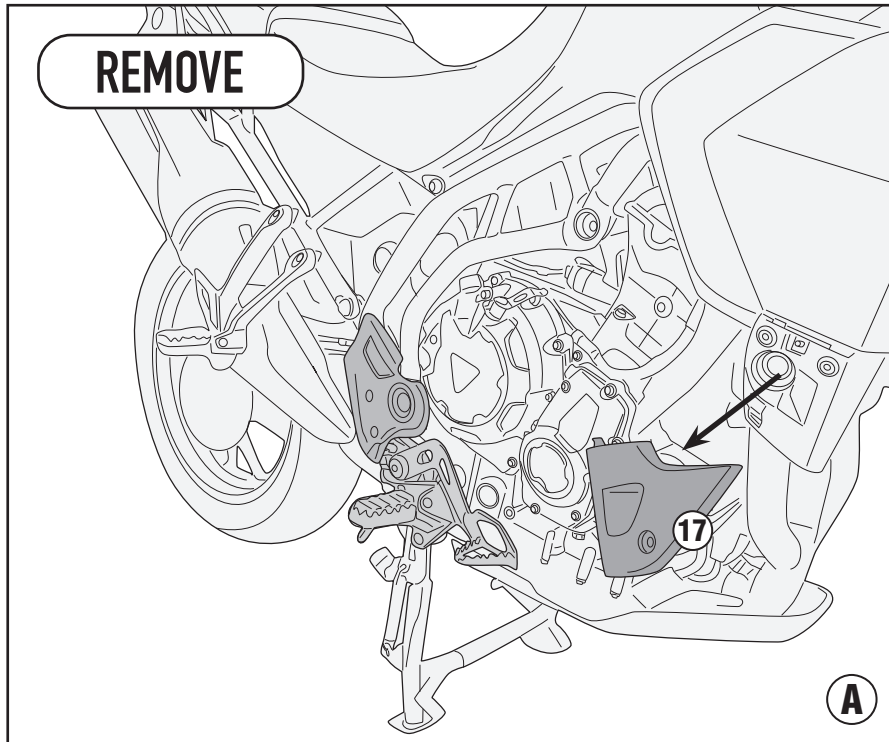

RIGHT SIDE

LEFT SIDE

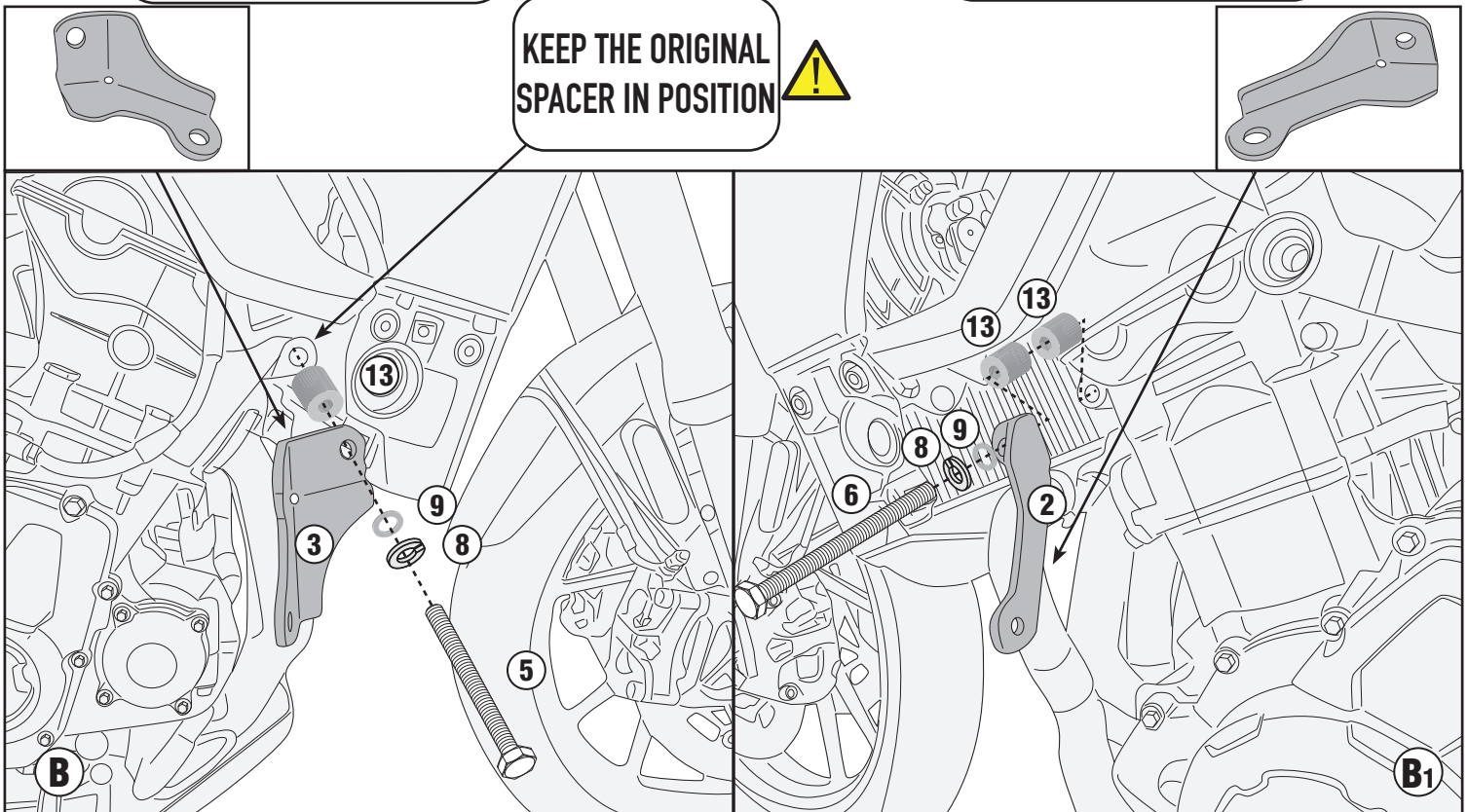

TN6415 - KN6415

TRIUMPH TIGER 900 (2020)

PARAMOTORE SPECIFICO - SPECIFIC ENGINE GUARD - PARE-CARTER SPECIFIQUE - SPEZIFISCHER STURZBÜGEL - DEFENSA DE MOTOR ESPECÍFICA - PARAMOTOR ESPECÍFICO



INSTALL THE LEFT SIDE FIRST

LEFT SIDE

REMOVE

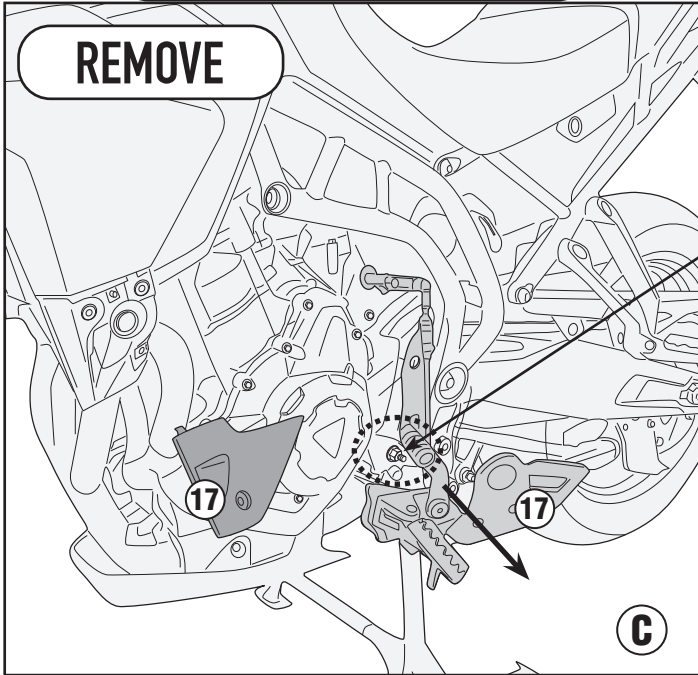

TO REMOVE THIS BOLT, IT IS NECESSARY TO HOLD THE SCREW ON THE RIGHT SIDE

RIGHT SIDE

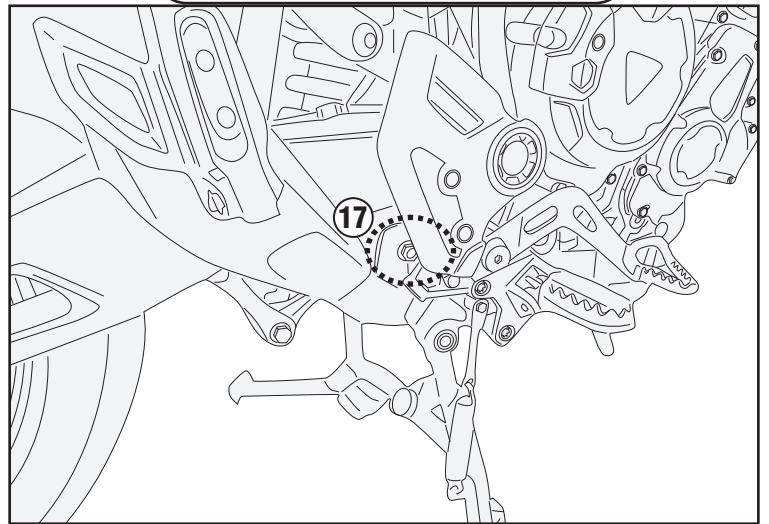

RIGHT SIDE

REMOVE

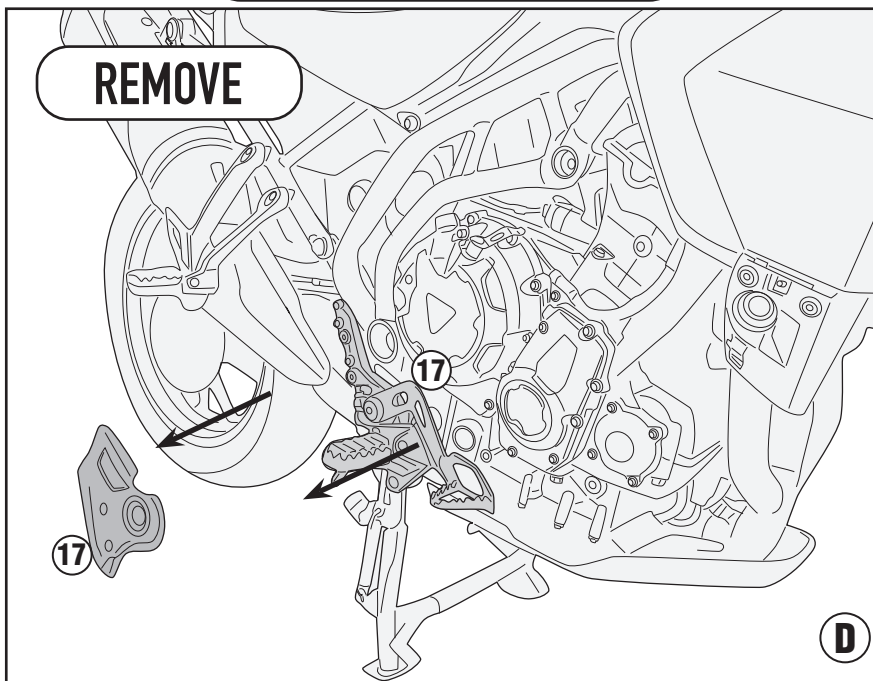

ISTRUZIONI DI MONTAGGIO - MOUNTING INSTRUCTIONS
INSTRUCTIONS DE MONTAGE - BAUANLEITUNG
INSTRUCCIONES DE MONTAJE - INSTRUÇÕES DE MONTAGEM

TN6415 - KN6415

TRIUMPH TIGER 900 (2020)

PARAMOTORE SPECIFICO - SPECIFIC ENGINE GUARD - PARE-CARTER SPECIFIQUE - SPEZIFISCHER STURZBÜGEL - DEFENSA DE MOTOR ESPECÍFICA - PARAMOTOR ESPECÍFICO

LEFT SIDE

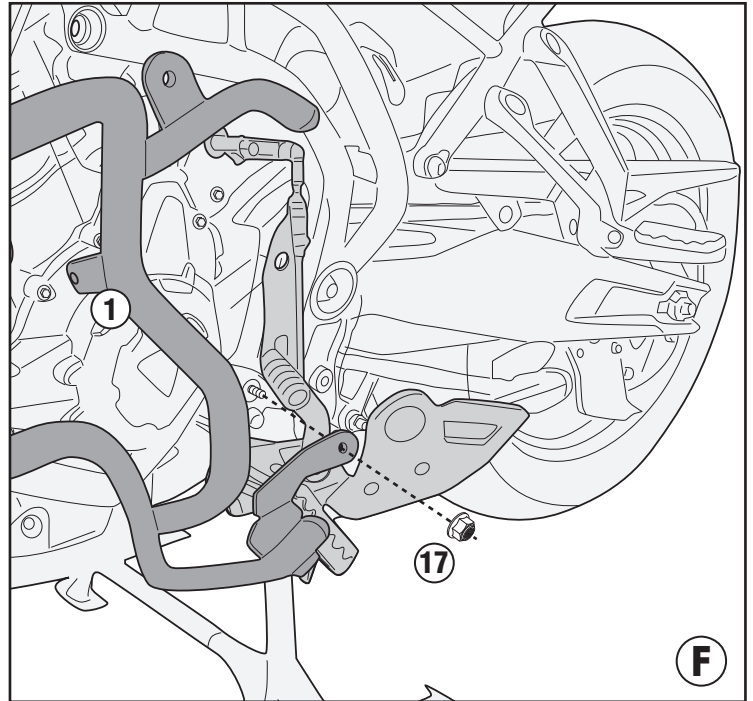
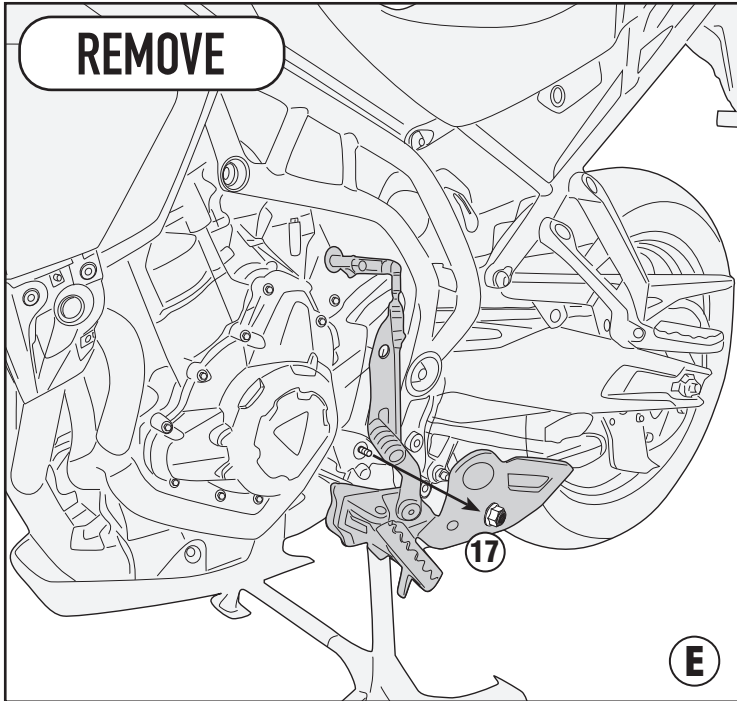

**KEEP THE ORIGINAL
SPACER IN POSITION**

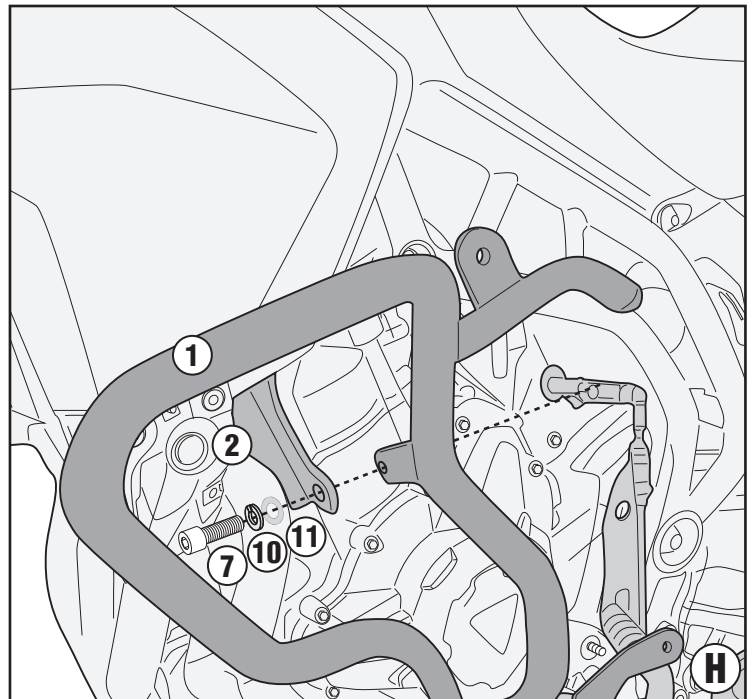
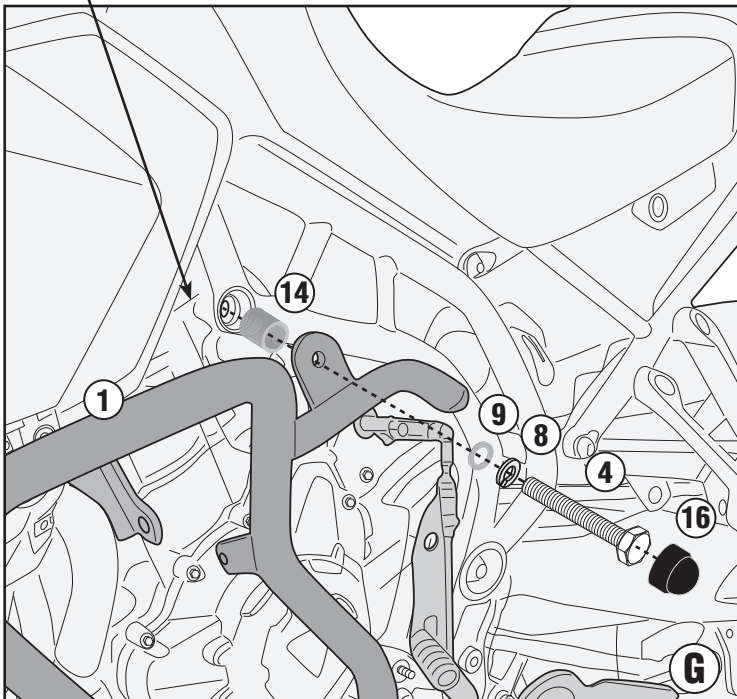

TN6415 - KN6415

TRIUMPH TIGER 900 (2020)

PARAMOTORE SPECIFICO - SPECIFIC ENGINE GUARD - PARE-CARTER SPECIFIQUE - SPEZIFISCHER STURZBÜGEL - DEFENSA DE MOTOR ESPECÍFICA - PARAMOTOR ESPECÍFICO

RIGHT SIDE

