



EVOTECH®
P E R F O R M A N C E

Husqvarna Vitpilen/Svartpilen
Tail Tidy

Installation Instructions

Kit Contents PRN014052

- (A) 1 x Reflector Kit
- (B) 1 x Rubber Cap
- (C) 1 x Grommet
- (D) 1 x Chain Adjuster Block
- (E) 2 x Indicator Stem
- (F) 2 x Indicator Nut
- (G) 2 x M5 x 10 Caphead Bolts
- (H) 2 x M5 x 12 Caphead Bolts
- (I) 2 x M5 x 10 C/sink Screws
- (J) 2 x 4mm Dowel Pins
- (K) 4 x M8 x 20 Black Button Head Bolts (Vitpilen Only)
- (L) 4 x M8 x 30 Black Button Head Bolts (Svartpilen Only)

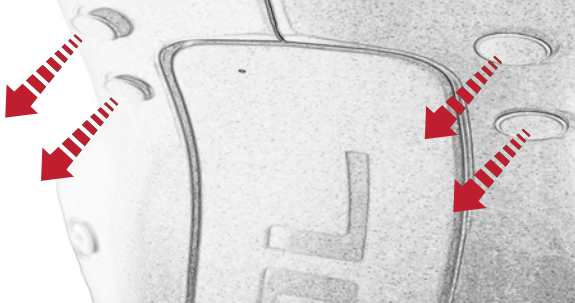

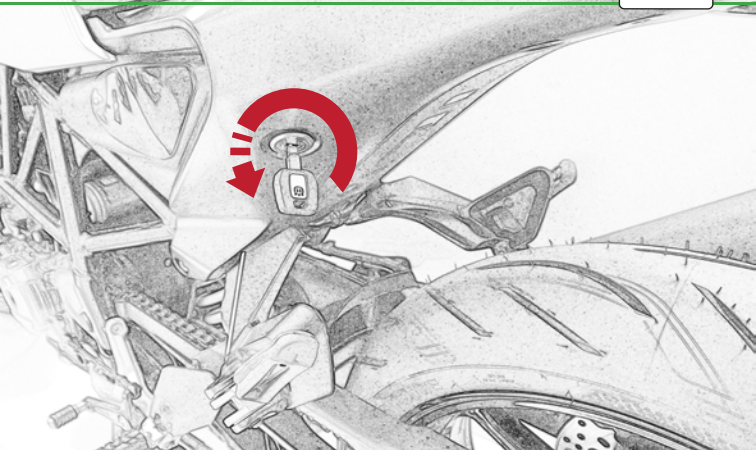

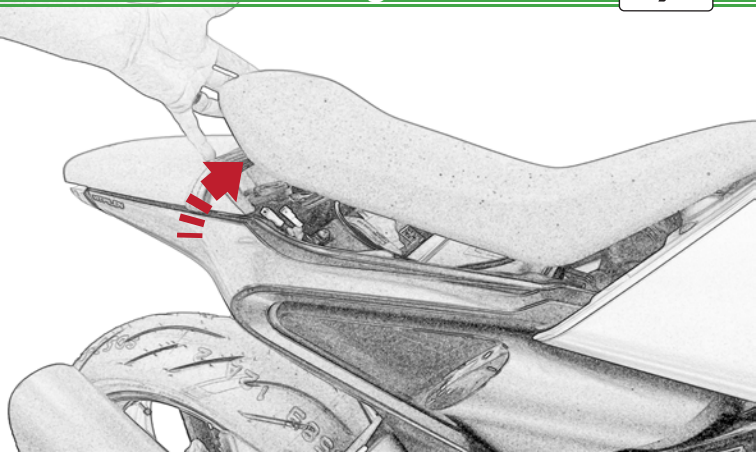

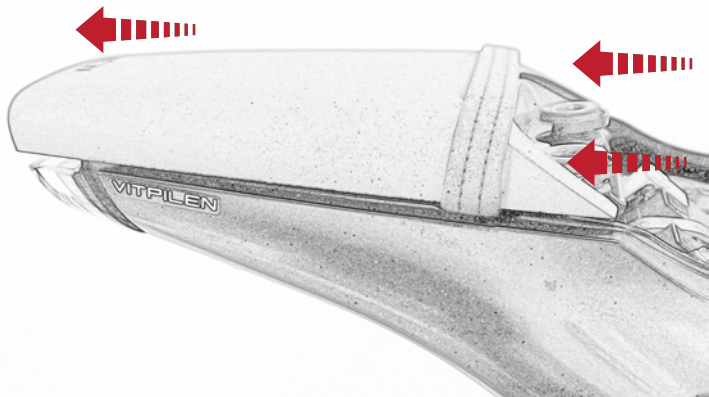

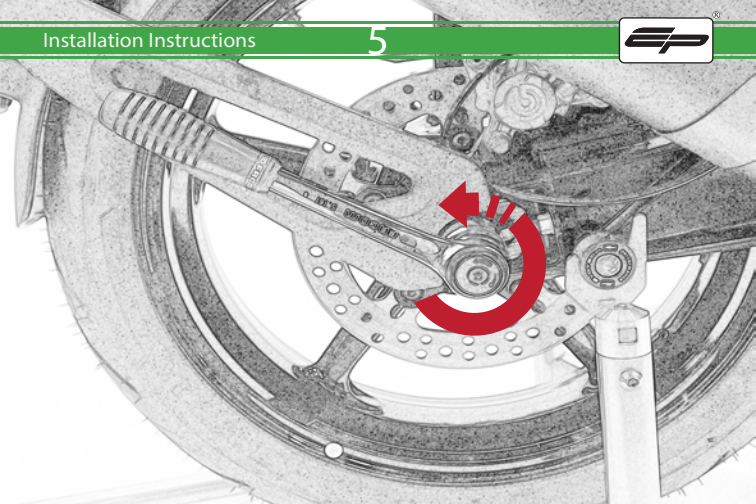

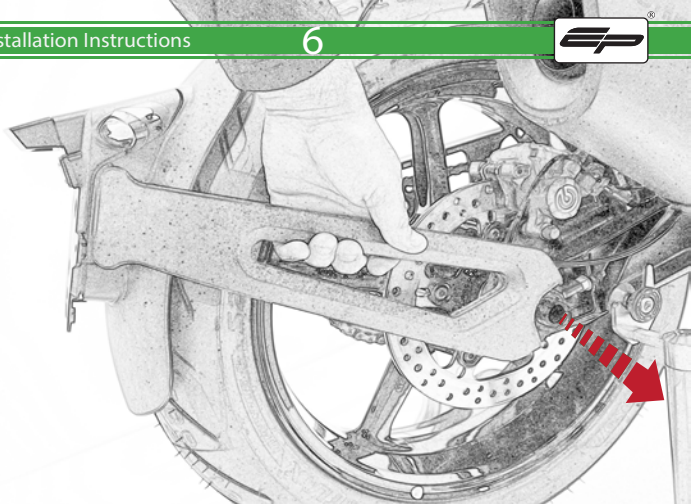

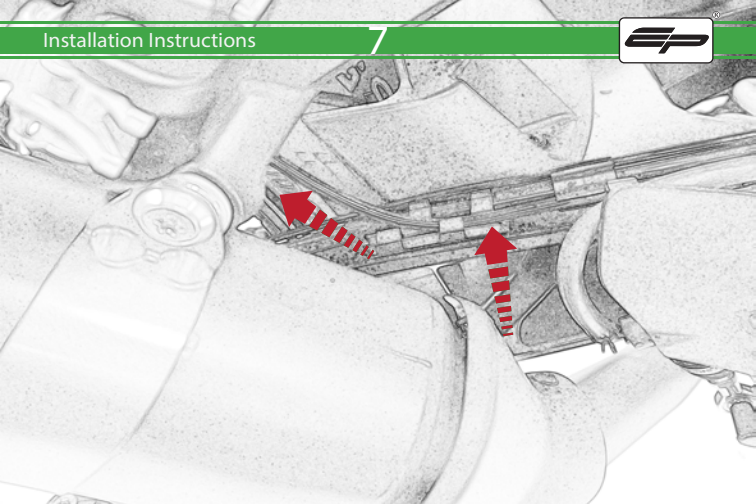

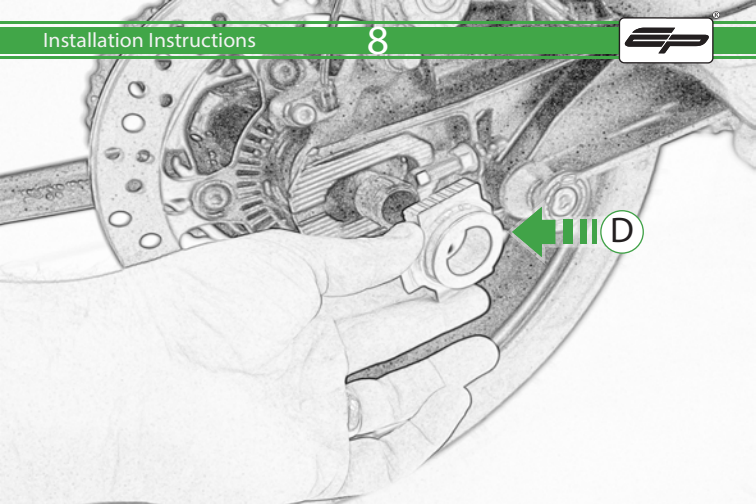

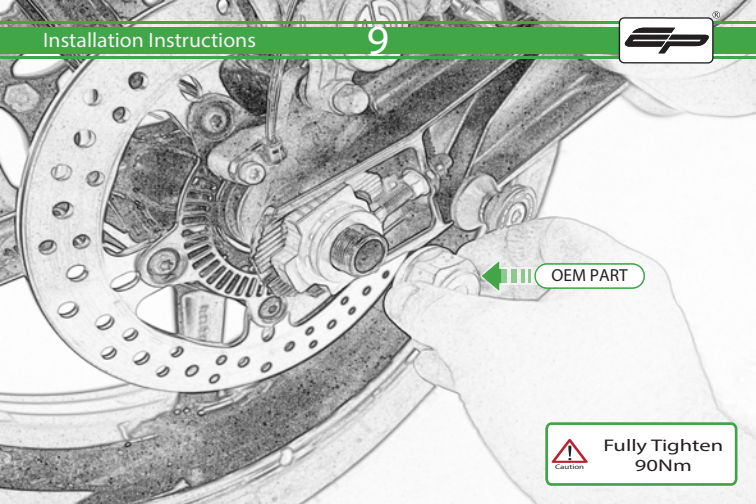

OEM PART



Fully Tighten
90Nm

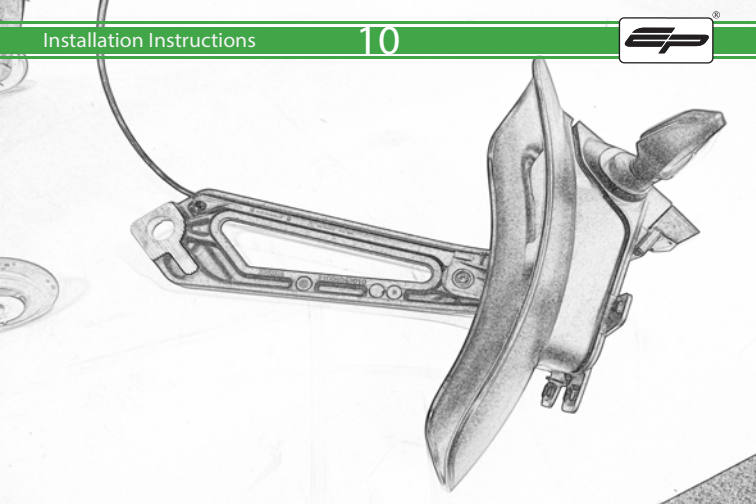

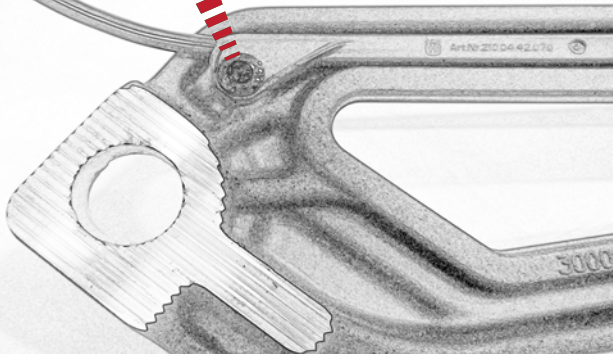

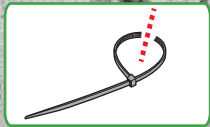
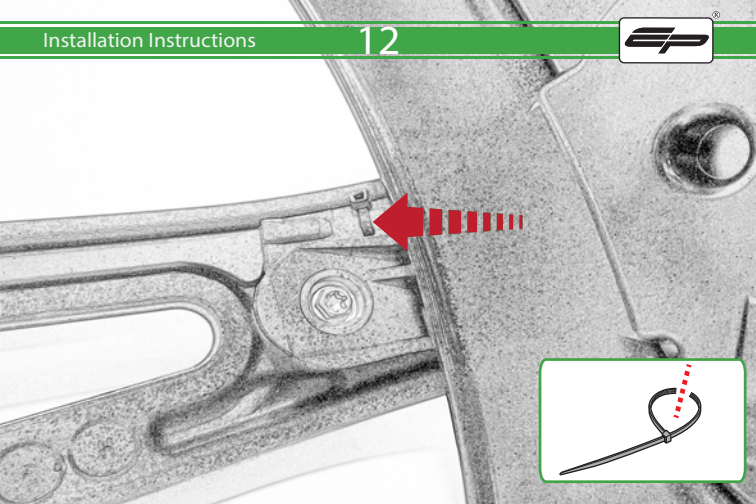

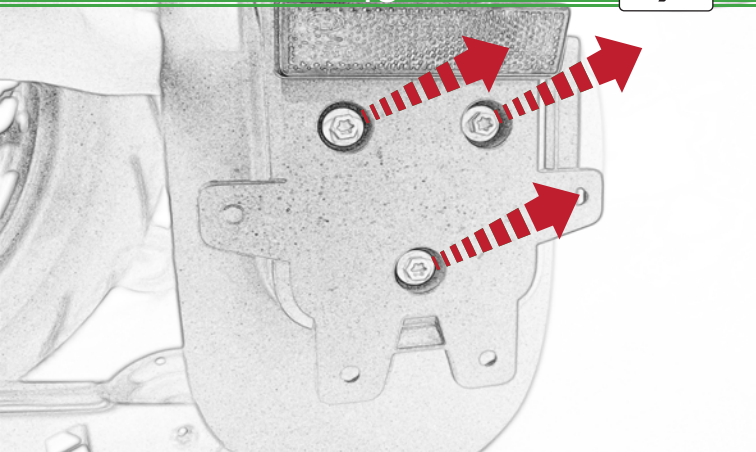

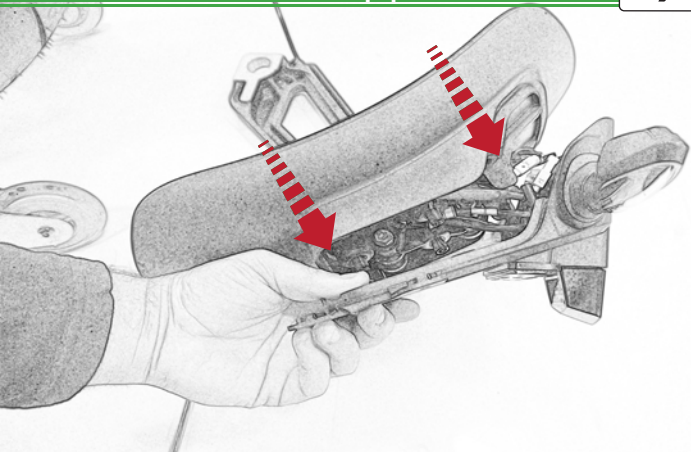

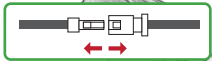
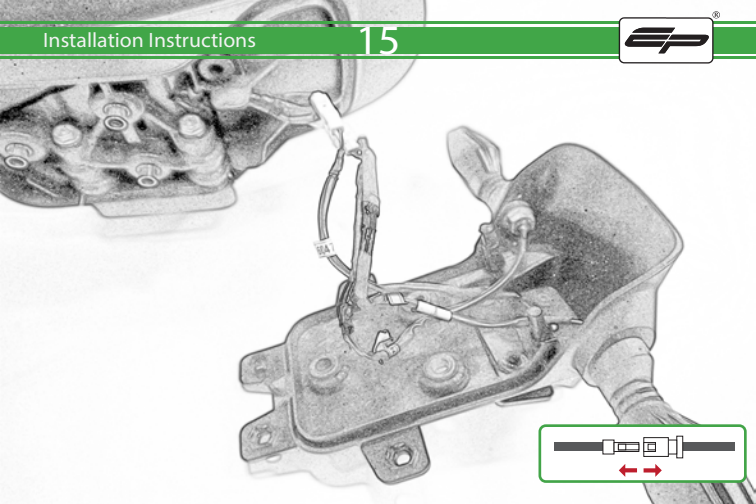

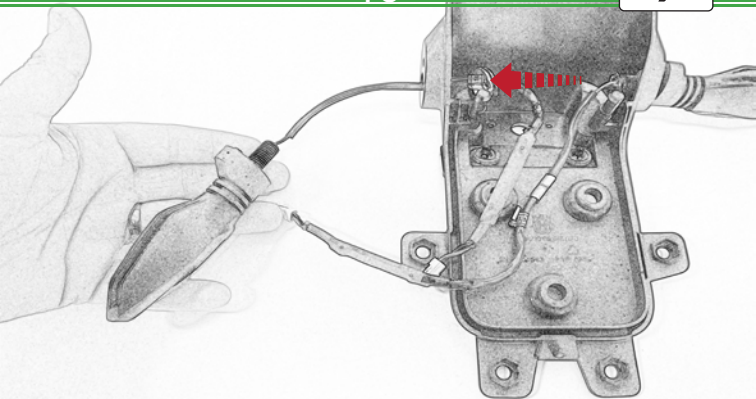

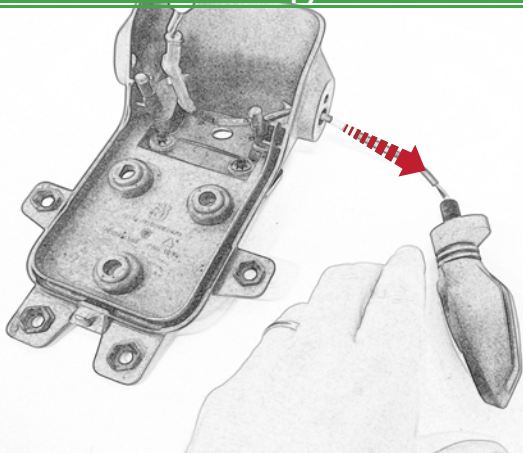

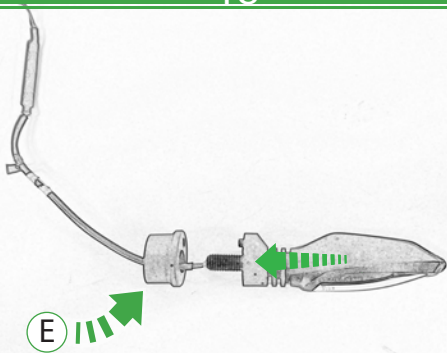

Repeat
Both Sides

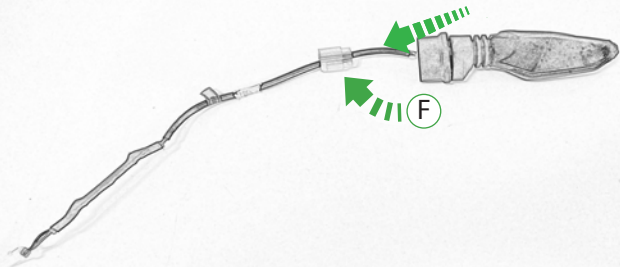

Repeat
Both Sides

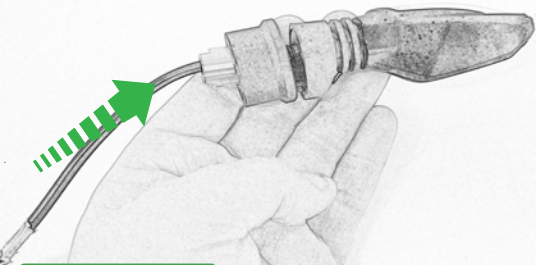

**Do Not Fully
Tighten**

**Repeat
Both Sides**

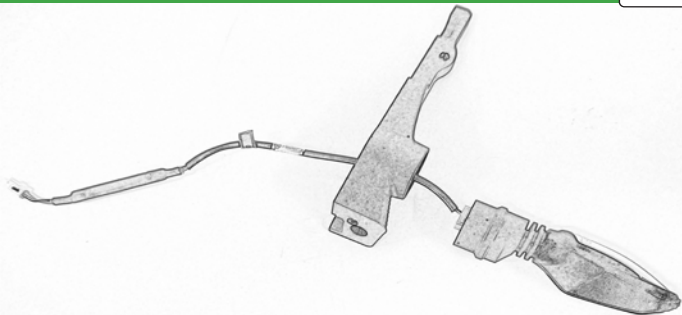

Repeat
Both Sides

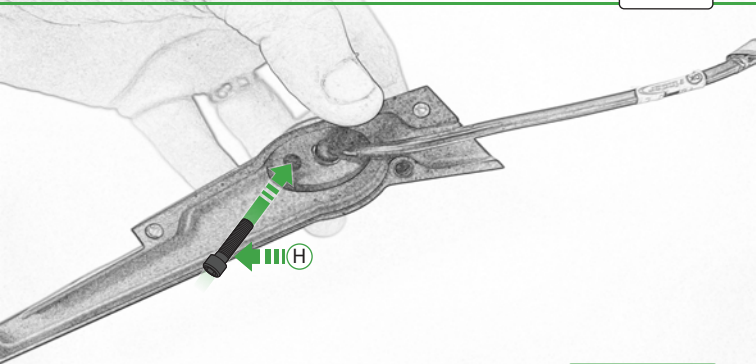

Repeat
Both Sides



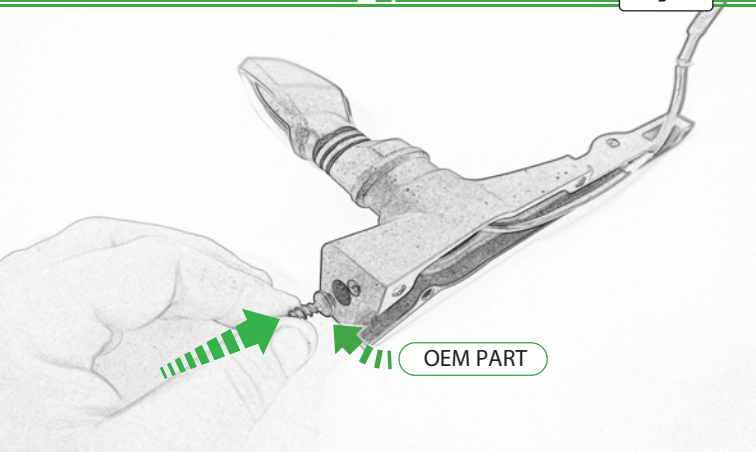

OEM PART

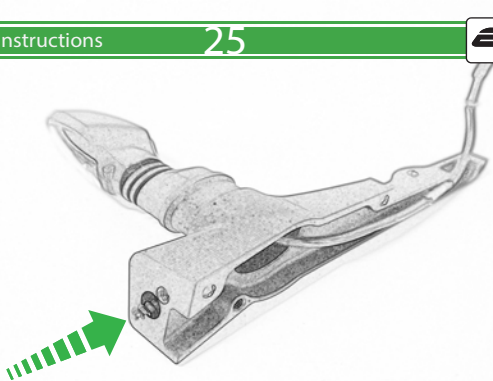

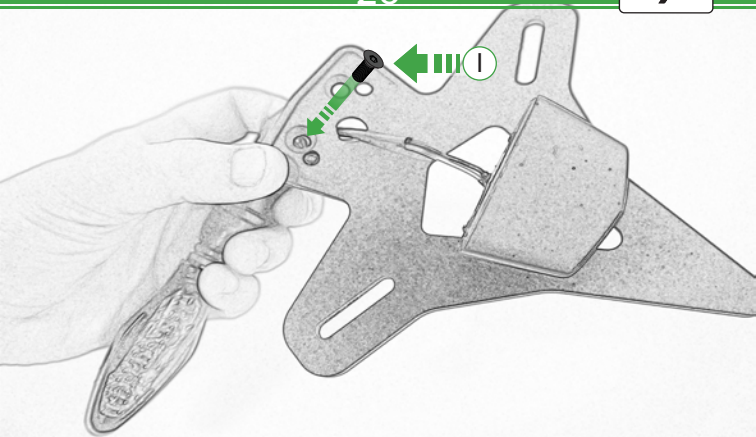

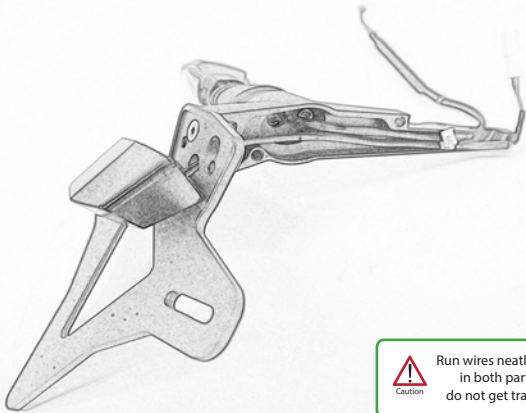

Caution

Run wires neatly down the channel
in both parts ensuring they
do not get trapped or squashed

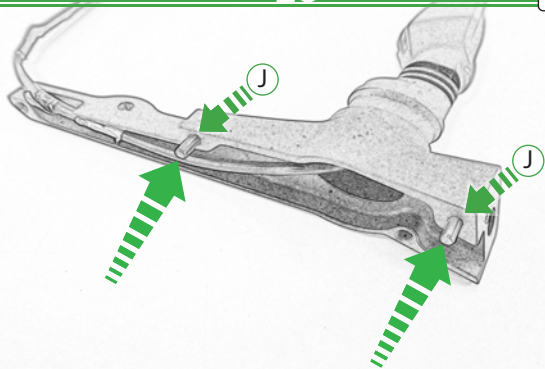

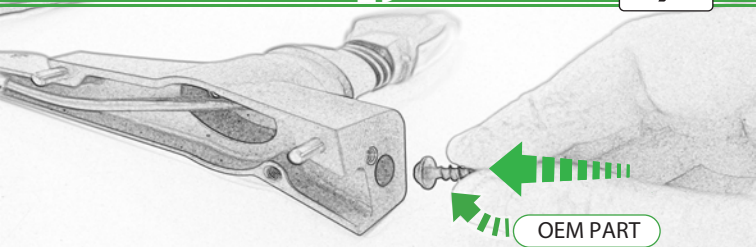

OEM PART

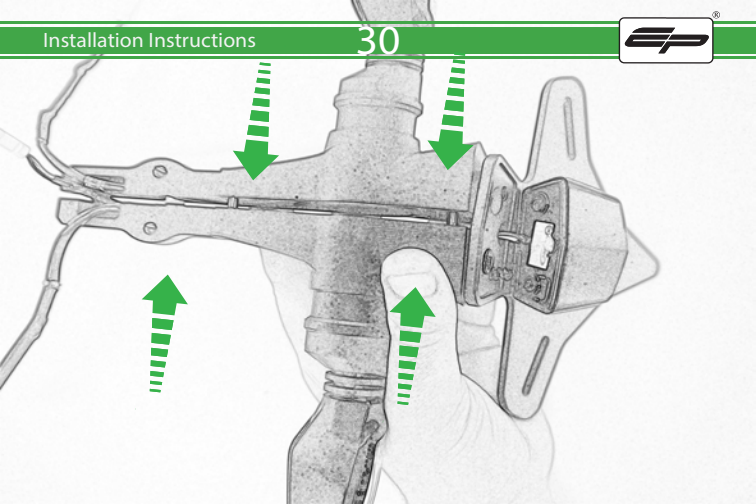

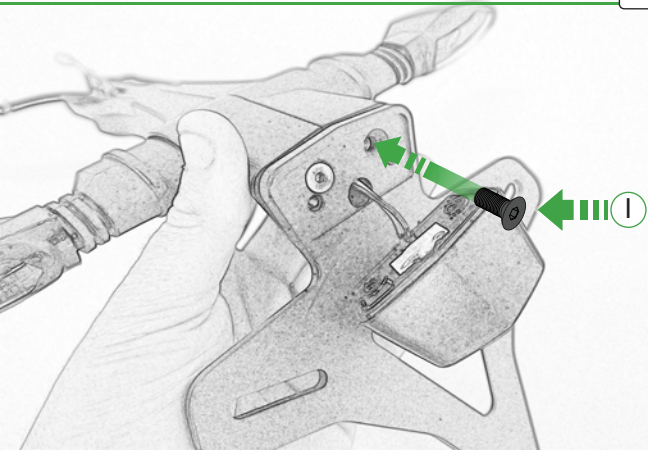

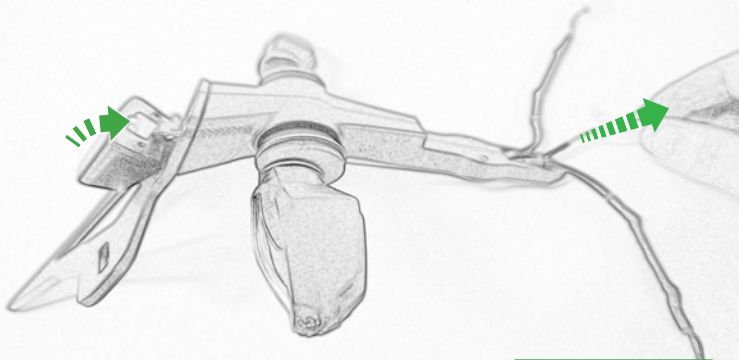

**Pull Wire
Through Tail Tidy**

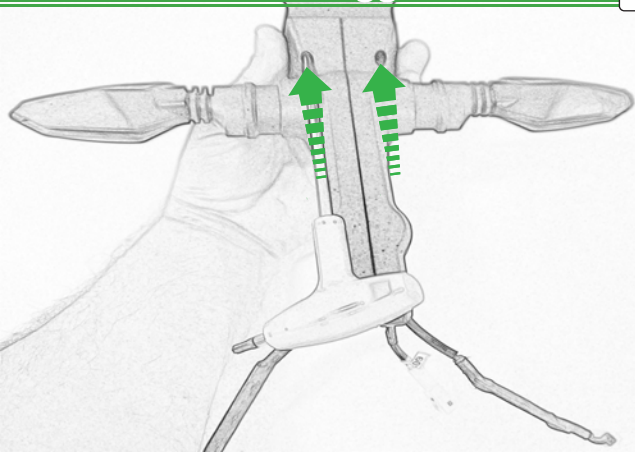

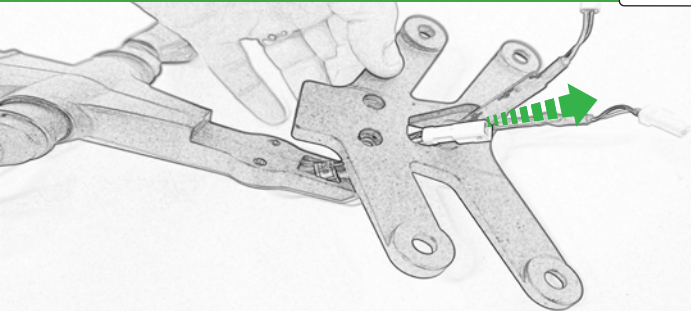

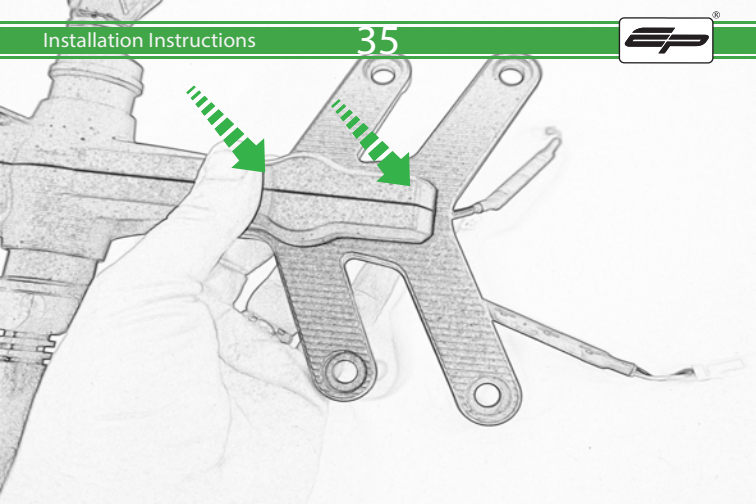

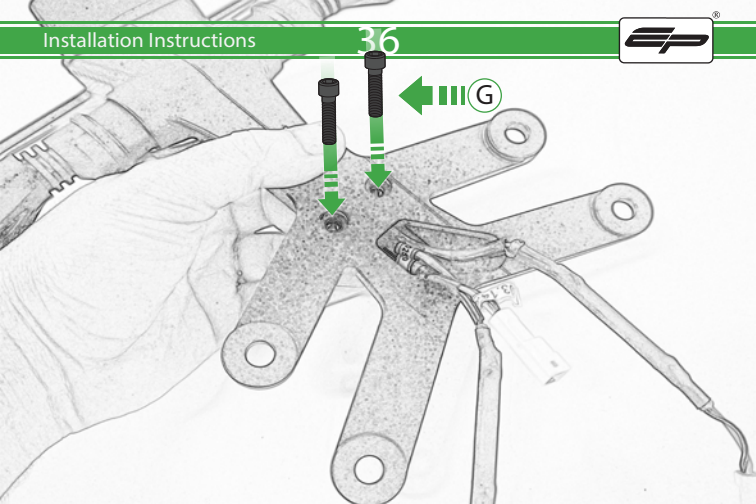



Use Target for
Drilling Hole

10750
06252600
104 - C

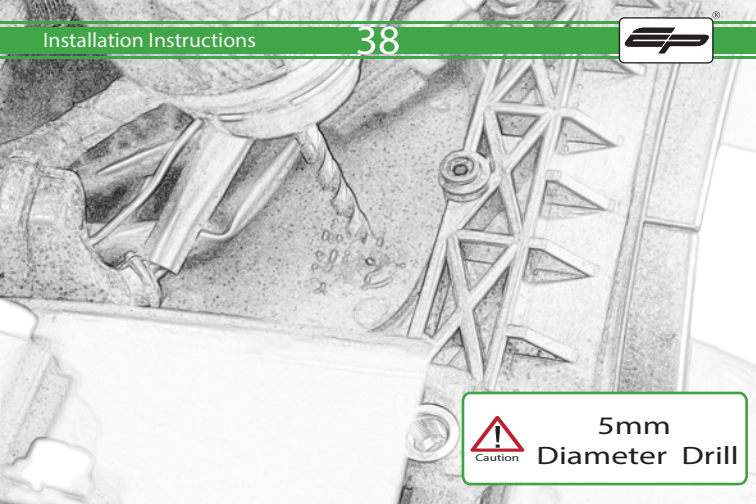

Caution

5mm
Diameter Drill

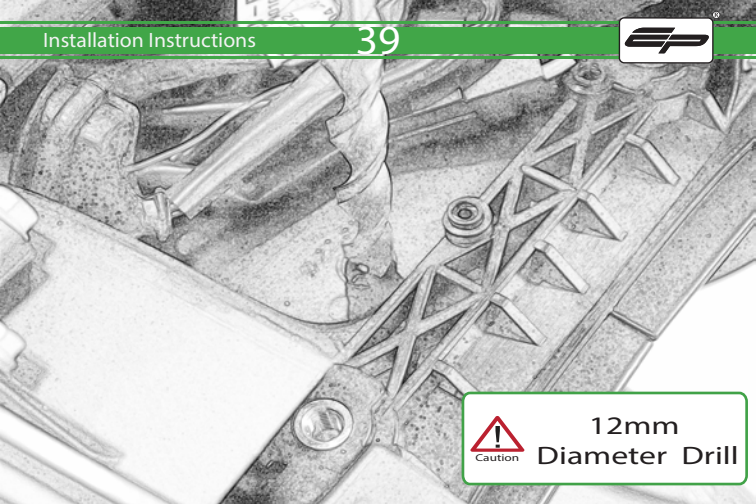

Caution

12mm
Diameter Drill

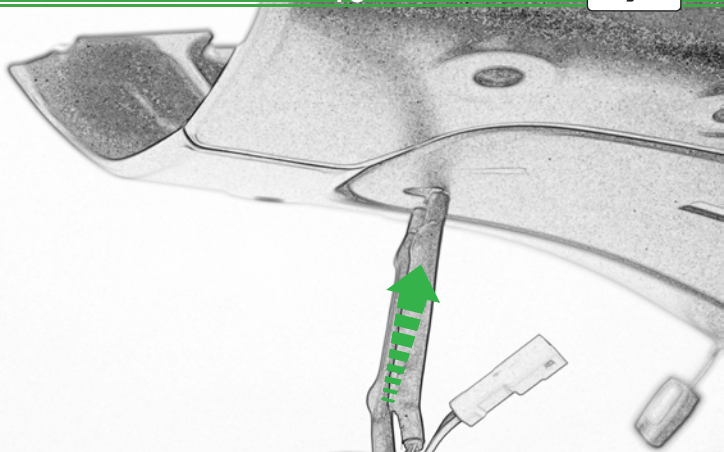

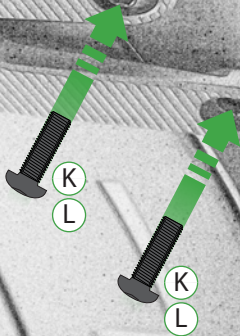
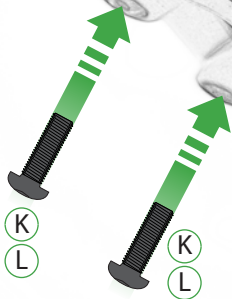

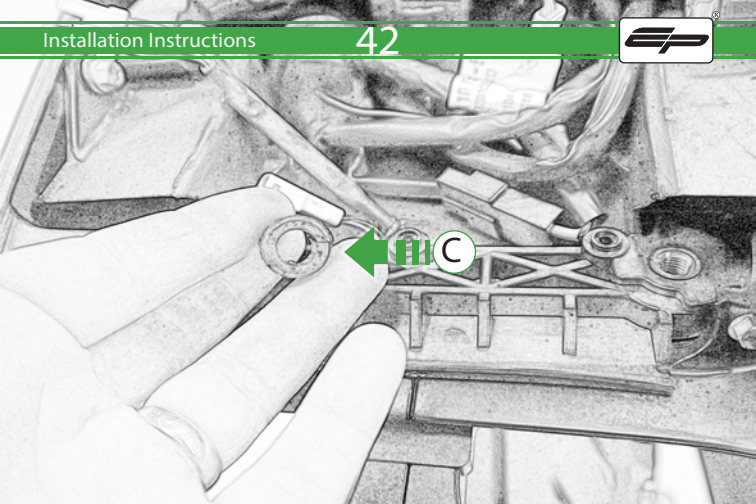

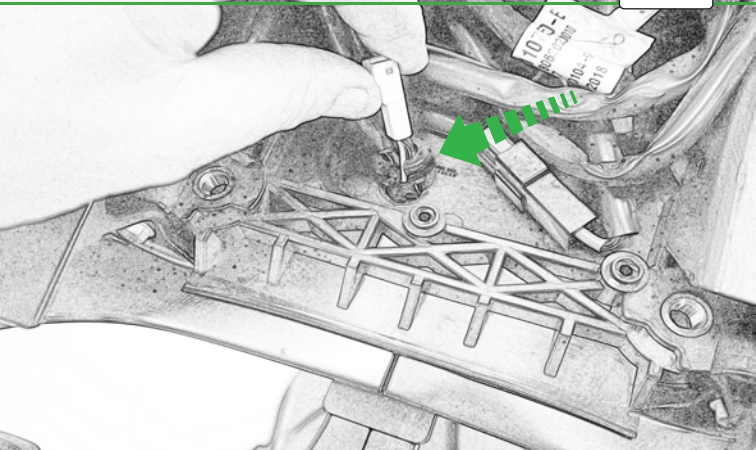

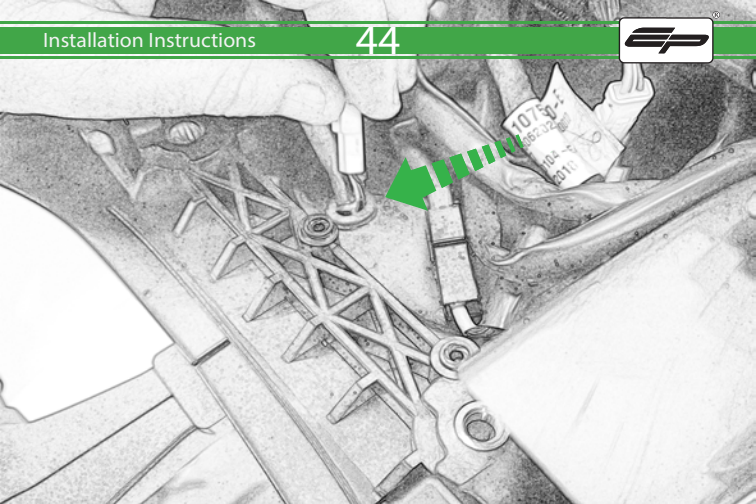

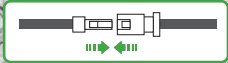
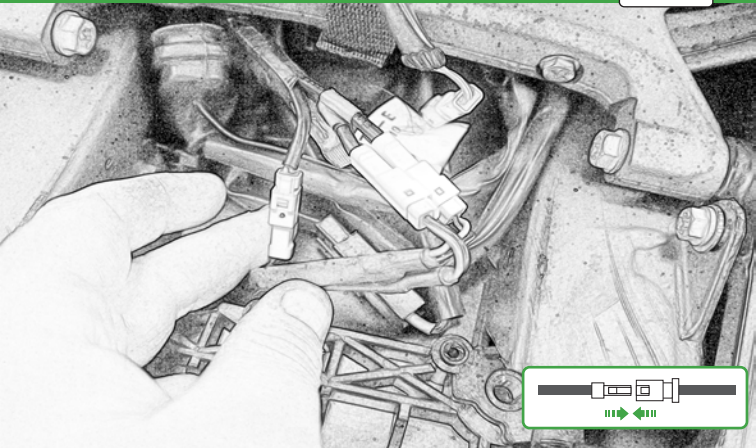



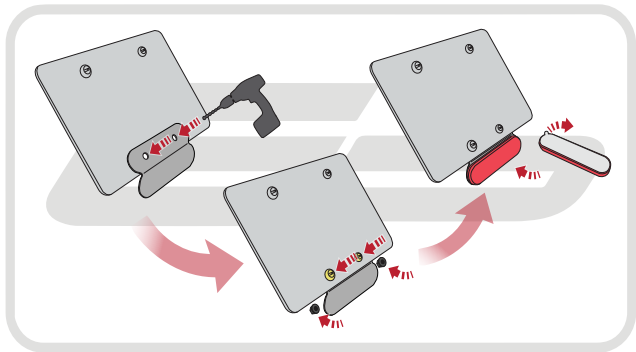

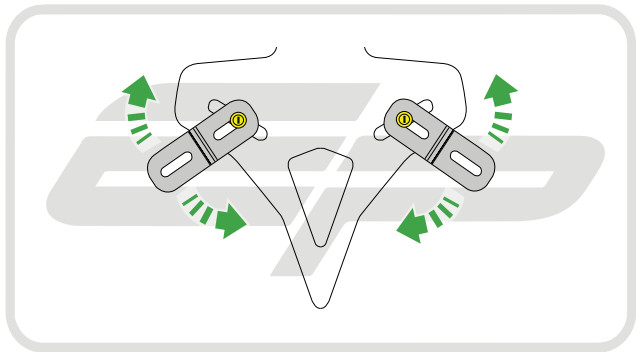



 **ESSENTIAL CHECKS** 

After installation of your tail tidy ensure that the licence plate does not contact the rear tyre when suspension is fully compressed.

Ensure all electrics including indicators, tail light, brake light and licence plate light lights are working correctly before riding the motorcycle.

It is recommended that periodic inspections are made to ensure that all fixings are fully tightend.



EVOTECH®
P E R F O R M A N C E

www.evotech-performance.com